

COTEK

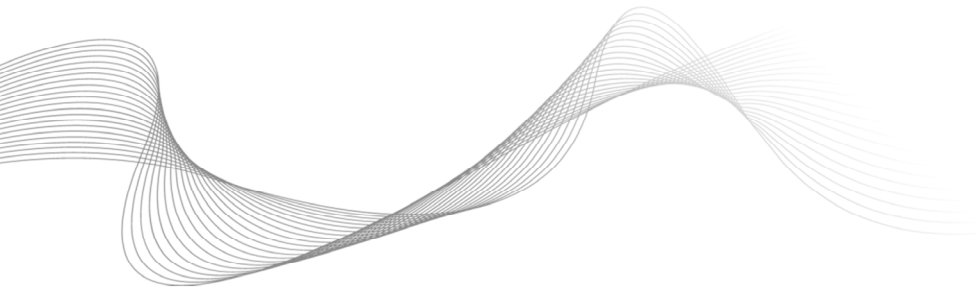

CX Series User's Manual ***Manuel utilisateur série CX***

Advanced Converter / Charger
Chargeurs de batterie multiphases

Legal Provisions

Copyrights 2017 COTEK Electronic IND. CO. All Rights Reserved.

Any part of this document may not be reproduced in any form for any purpose without the prior written permission of COTEK Electronic IND. CO. For the conditions of the permission to use this manual for publication, contact COTEK Electronic IND. CO., LTD. In all related COTEK product activities, Neither COTEK Electronic IND. CO., LTD. nor its distributors or dealers be liable to anyone for indirect, incidental, or consequential damages under any circumstances. Specifications are subject to change without notice. Every attempt has been made to make this document complete, accurate and up-to-date. COTEK Electronic IND. CO., LTD reserve the right to make changes without notice and shall not be responsible for any damages, including indirect, incidental or consequential damages, caused by reliance on the material presented, including, but not limited to, omissions, typographical errors, arithmetical errors or listing errors in the content material. All trademarks are recognized even if these are not marked separately. Missing designations do not mean that a product or brand is not a registered trademark.

Dispositions légales

Copyrights 2017 COTEK Electronic IND. CO. tous droits réservés.

Aucune partie de ce document ne peut être reproduite, quelle qu'en soit la manière et quel qu'en soit le but, sans autorisation préalable écrite de COTEK Electronic IND. CO. Pour obtenir l'autorisation de publier ce manuel, adressez-vous directement à COTEK Electronic IND. CO., LTD. Pour l'ensemble des activités COTEK, ni COTEK Electronic IND. CO., LTD. ni ses distributeurs ou revendeurs ne sauraient être tenus responsables, d'aucune manière, de tout dommage direct, indirect ou accessoire. Les caractéristiques peuvent être modifiées sans notification préalable. Tout a été mis en œuvre pour que ce document soit complet, précis et à jour. COTEK Electronic IND. CO., LTD. se réserve le droit d'apporter des modifications sans notification et ne saurait être tenu responsable de tout dommage direct, indirect ou accessoire causé par l'utilisation de ce contenu, y compris mais non limité à des omissions, des coquilles, des erreurs de calcul ou de description. Toutes les marques sont protégées même sans indication spécifique. L'absence de logo ne signifie pas que le produit ou la marque ne sont pas protégés.

Table of Content

1. Important Safety Information	1
1-1. General Safety Precautions	1
1-2. Battery Precautions	2
2. Features	3
2-1. Battery Charging Curve	4
2-2. Specification	6
2-3. Mechanical Drawings	9
3. Product Description	13
3-1. Configurations	13
3-2. S1 Setting	14
3-3. Charging Status LED Indicator	15
3-4. Failure Indicator	15
3-5. Pin Assignment of CN2 – For Alarms Signal & Fan Control	16
3-6. Sleep Mode	16
3-7. Pin Assignment of CN3 – For Temperature sensor & Remote control	16
3-8. Pin Assignment of CN4 – For Remote control	17
3-9. Pin Assignment of ESB Connectors – For CX1215/1225/1235	17
3-10. Temperature Compensation	17
3-11. Rescue Battery Curve	18
3-12. Battery Charger Selection (Reference only)	19
3-13. Battery Voltage setting suggestion	19
3-14. Fan speed duty description	20

4. Installing Converter / Charger	21
4-1. Battery charger connection diagram	23
5. Trouble Shooting	27
6. Warranty Statement	28
6-1. Warning	28
6-2. Warranty	28

1. Important Safety Information



Warning!

Before installing or using CX series power converter, you need to read following safety information carefully.

1-1. General Safety Precautions

- 1-1-1. For indoor use, do not expose CX-Series Battery Charger to water, mist, snow, or dust. To reduce the risk of fire, do not cover or obstruct the ventilation enclosure.
- 1-1-2. To avoid the risk of fire and electric shocks, make sure that existing wiring is in good electrical condition and not undersized.
- 1-1-3. Do not charge non-rechargeable batteries.
- 1-1-4. Disconnect the AC Grid before making or breaking the connections to the battery.
- 1-1-5. Only the AC cord with IEC socket is allowed to plug to the battery charger.
- 1-1-6. Never charge a frozen battery.
- 1-1-7. If the AC cord is damaged do not attempt to use. It must be replaced or repaired by a qualified person.
- 1-1-8. Corrosive substances may escape from the battery during charging and damage delicate surfaces. Please store and charge in a suitable area.

1-2. Battery Precautions

- 1-2-1. If battery acid contacts your skin or clothing, wash it out with soap and water immediately.
- 1-2-2. If battery acid contacts your eyes, wash it out with cold running water for at least 20 minutes and get medical attention immediately.
- 1-2-3. Never smoke or make a spark or flame in the vicinity of the battery.
- 1-2-4. Do not drop metals on the battery.
The resulting sparks or short-circuits on the battery or other electrical parts may cause an explosion.
- 1-2-5. Remove personal metal items such as rings, bracelets, necklaces, and watches when operating with lead-acid batteries. It may cause short circuit and very high temperature, which can melt metal items.

2.Features

- Universal AC input with active PFC
- Compatible with Lead Acid, Li-ion, Gel and AGM batteries
- Support remote controller CR-1 as optional accessory
- Voltage / temperature compensation
- 2 stage fan speed control (Sleep mode)
- Output power OK signal
- Output alarm signal
- High efficiency and high reliability
- Built-in battery rescue function
- Built-in Extra Second Battery (ESB) output function
- Protection Short Circuit / Over Voltage / Over Temperature / Brown-out Protection
- Withstand 2G vibration test

2-1. Battery Charging Curve

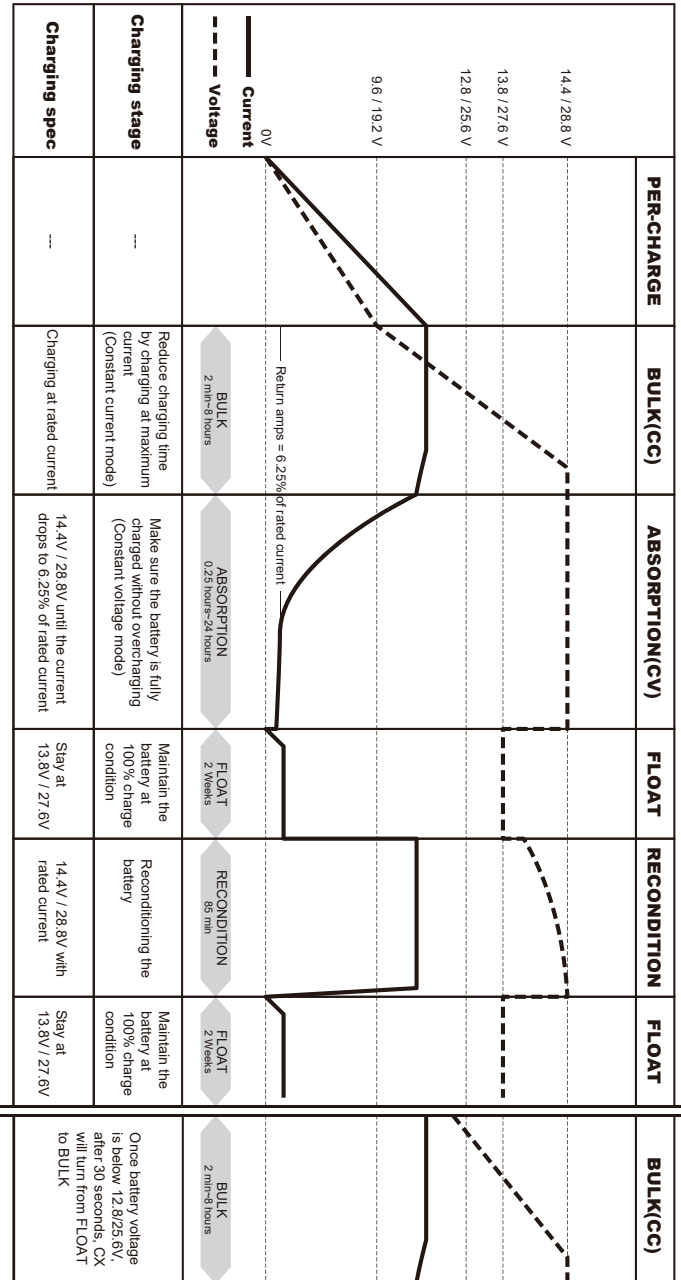

Figure 1. CX series Battery Charging Curve

2-1-1. Bulk Stage (Constant Current)

At the beginning of the charging process, the flat battery is charged at constant current (maximum charge current) until the battery voltage reaches the set charging voltage (Refer to 3-2 charging mode setting).

2-1-2. Absorption Stage (Constant Voltage)

The absorption charging duration will depend on the battery status.

Before moving to absorption stage, charger will wait for two minutes then charging at constant voltage until the battery is fully charged.

Once the battery is fully charged or the charging current is below 6.25% of the rated charging current for 15 minutes, then the absorption stage ends.

2-1-3. Float Stage

After absorption stage, the battery charger switches to float stage, maintains the battery at 100% charge without overcharging or damaging the battery. This means the charger can be left connected to the battery continuously.

2-1-4. Recondition stage

Every 14 days, the battery charger switches back to Bulk stage for 85 minutes in order to revive the battery. This prevents any fatigue symptoms such as sulphation.

2-2. Specification

Model		CX1215	CX1225	CX1235	CX1250	CX1280
Output	Battery Type	Lead Acid / Li-ion / Gel / AGM				
	Standard Boost Charge Voltage	14.4V / 14.7V (Select by S1 DIP switch)				
	Standard Float Charge Voltage	13.8V / 13.5V (Select by S1 DIP switch)				
	Main Rated Current	15A	25A	35A	50A	80A
	Main Output	1	2	2	3	3
	ESB Output	1	1	1	--	--
	ESB Output Voltage / Current	13.8V/2A	13.8V/2A	13.8V/2A	--	--
	Battery Charging Mode	3-stage charging capability IUOU				
	Isolation Type	Use active power MOSFET on each output terminal				
Single Output Current Limit	15A	25A	35A	40A	40A	
Input	Nominal Voltage	100~240VAC (100~120VAC only for UL458)				
	Voltage Range	90~264VAC (90~132VAC only for UL458) (Refer to 2-2-2 de-rating curve)				
	Frequency Range	47~63Hz				
	Power Factor (Typ.)	PF > 0.92 at full load				
	Efficiency (Typ.) at 230Vac	87%	87%	87%	87%	87%
Protection	Short Circuit	Current is reduced to < 1A continued 30sec., will operate 30 seconds then turn off				
	Over Voltage	17.5V \pm 1%, protection type: shut down output (recovery after resetting AC power ON)				
	Over Temperature	Charger Over Temperature 100 \pm 5°C detected by heat sink 52 \pm 5°C (Optional temperature sensor) Auto recovery after heat sink temperature goes down to 50 \pm 5°C				
Function	Alarm Signal	NC. / NO. Relay contact output (Please reference Alarms signal & Fan control)				
	Temp. Compensation	12V : -10mv / 0.5°C with COTEK temperature sensor 24V : -20mv / 0.5°C with COTEK temperature sensor				
	Sleep Mode	By Remote Controller and S1-4 DIP switch (Please refer to section 3-2)				
	Remote Controller	Support COTEK Remote Controller CR-1 (Refer to section 3-6 and 3-7)				
Environment	Working Temperature	-20~40°C (Refer to 2-2-2 de-rating curve)				
	Working Humidity	20~90% RH non-condensing				
	Temperature Coefficient	\pm 0.03% (0~50°C)				
	Vibration	10~500Hz, 2G 10min. / 1cycle period for 60min. each along X, Y, Z axes.				
Safety & EMC	Safety Standards	Certified EN 60335-1, EN 60335-2-29, UL458 (only for CX1235/1250/1280)				
	Withstand Voltage	I/P-O/P: 4242VDC, I/P-FG: 1768VDC, O/P-FG: 707VDC				
	Isolation Resistance	I/P-O/P: 100M Ohms / 500VDC				
	EMC Standards	Certified EN 55022; EN 61204-3; EN 55014-1 Certified EN 61000-3-2; EN 61000-3-3; EN 61204-3; EN 61000-6-3 Certified EN 55024; IEC 61000-4-2, 3, 4, 5, 6, 8, 11; ENV 50204; EN 61000-6-1; EN 55014-2				
Others	Dimension (WxHxD)	183x72x243 mm		183x72x263 mm	213x77x272 mm	213x77x312 mm
	Packing	1.6 kg	1.7 kg	1.9 kg	3.1 kg	4.0 kg

Model		CX2415	CX2425	CX2440
Output	Battery Type	Lead Acid / Li-ion / Gel / AGM		
	Standard Boost Charge Voltage	28.8V / 29.4V (Select by S1 DIP switch)		
	Standard Float Charge Voltage	27.6V / 27V (Select by S1 DIP switch)		
	Main Rated Current	12.5A	25A	40A
	Main Output	2	3	3
	ESB Output	--	--	--
	ESB Output Voltage / Current	--	--	--
	Battery Charging Mode	3-stage charging capability IUOU		
	Isolation Type	Use active power MOSFET on each output terminal		
Single Output Current Limit	12.5A	25A	40A	
Input	Nominal Voltage	100~240VAC (100~120VAC only for UL458)		
	Voltage Range	90~264VAC (90-132VAC only for UL458) (Refer to 2-2-2 de-rating curve)		
	Frequency Range	47~63Hz		
	Power Factor (Typ.)	PF > 0.92 at full load		
	Efficiency (Typ.) at 230Vac	90%	90%	90%
Protection	Short Circuit	Current is reduced to < 1A continued 30sec., will operate 30 seconds then turn off		
	Over Voltage	35V ±1%, protection type: shut down output (recovery after resetting AC power ON)		
	Over Temperature	Charger Over Temperature 100 ±5°C detected by heat sink		
		52±5°C (Optional temperature sensor) Auto recovery after heat sink temperature goes down to 50±5°C		
Function	Alarm Signal	NC. / NO. Relay contact output (Please reference Alarms signal & Fan control)		
	Temp. Compensation	12V : -10mv / 0.5°C with COTEK temperature sensor 24V : -20mv / 0.5°C with COTEK temperature sensor		
	Sleep Mode	By Remote Controller and S1-4 DIP switch (Please refer to section 3-2)		
	Remote Controller	Support COTEK Remote Controller CR-1 (Refer to section 3-6 and 3-7)		
Environment	Working Temperature	-20~40°C (Refer to 2-2-2 de-rating curve)		
	Working Humidity	20~90% RH non-condensing		
	Temperature Coefficient	±0.03% (0~50°C)		
	Vibration	10~500Hz, 2G 10min. / 1cycle period for 60min. each along X, Y, Z axes.		
Safety & EMC	Safety Standards	Certified EN 60335-1, EN 60335-2-29, UL458 (only for CX2425/2440)		
	Withstand Voltage	I/P-O/P: 4242VDC, I/P-FG: 1768VDC, O/P-FG: 707VDC		
	Isolation Resistance	I/P-O/P: 100M Ohms / 500VDC		
	EMC Standards	Certified EN 55022; EN 61204-3; EN 55014-1 Certified EN 61000-3-2; EN 61000-3-3; EN 61204-3; EN 61000-6-3 Certified EN 55024; IEC 61000-4-2, 3, 4, 5, 6, 8, 11; ENV 50204; EN 61000-6-1; EN 55014-2		
Others	Dimension (WxHxD)	183x72x243 mm	213x77x272 mm	213x77x312 mm
	Packing	1.6 kg	2.9 kg	3.9 kg

2-2-1. Charging Current vs. Ambient Temperature De-rating Curve

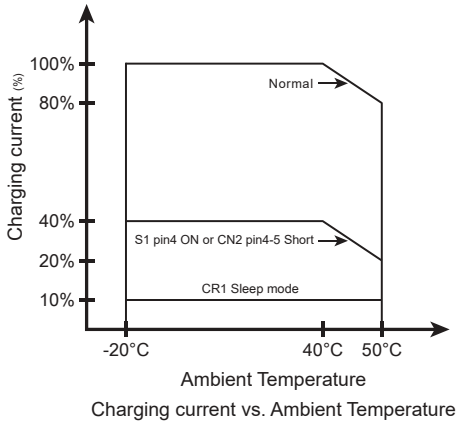

Figure 2. Charging current vs. Ambient temperature de-rating curve

2-2-2. Charging Current vs. Input Voltage Temperature De-rating Curve

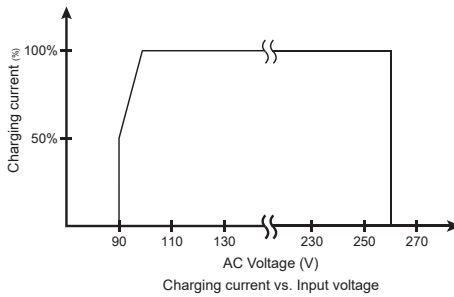

Figure 3. Charging current vs. Input voltage temperature de-rating curve

2-3. Mechanical Drawings

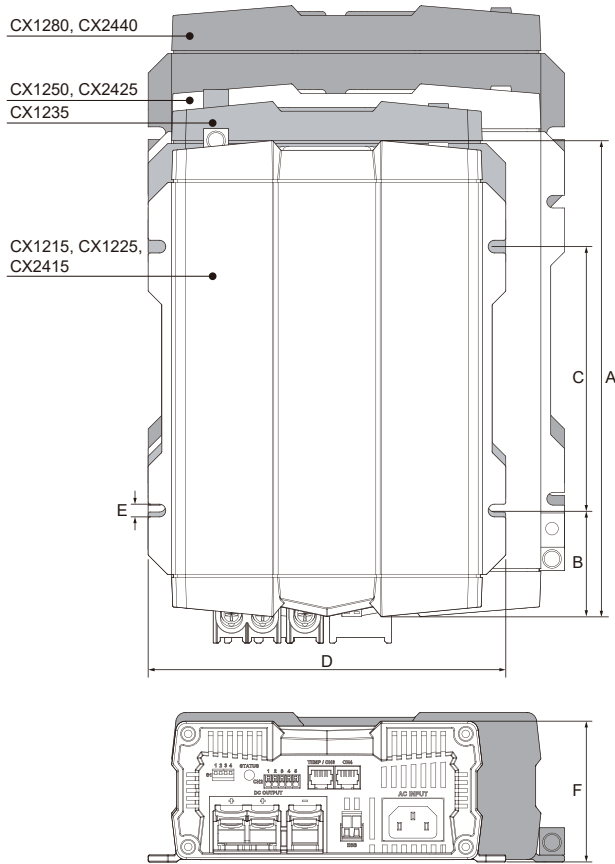

Figure 4. Mechanical Drawings

Model	A (mm)	B (mm)	C (mm)	D (mm)	E (mm)	F (mm)
CX1215	243	54.2	135.0	183	6.5	72
CX1225	243	54.2	135.0	183	6.5	72
CX1235	263	56.7	150.0	183	6.5	72
CX1250	272	60.2	152.0	213	6.5	77
CX1280	312	65.2	182.0	213	6.5	77
CX2415	243	54.2	135.0	183	6.5	72
CX2425	272	60.2	152.0	213	6.5	77
CX2440	312	65.2	182.0	213	6.5	77

2-3-1. CX1215 / 1225 / 1235 / 2415 (Front Panel)

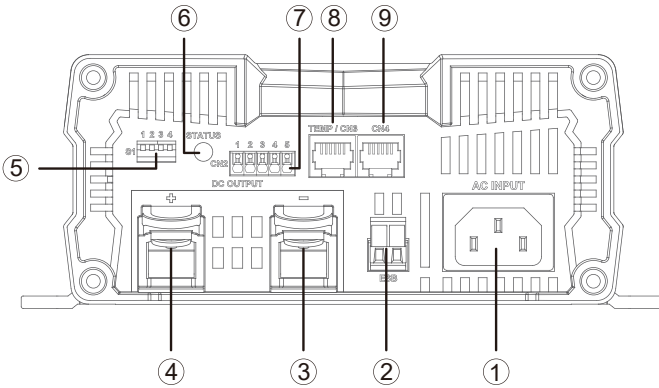

Figure 5. CX1215 front panel

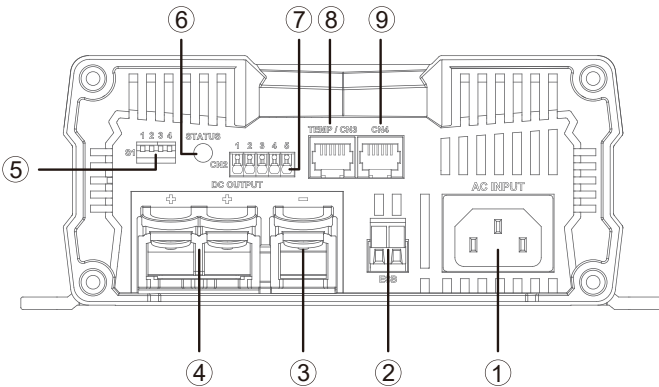

Figure 6. CX1225/1235/2415 front panel

Front panel			
①	AC Inlet (IEC)	⑥	Status LED
②	ESB connector (only CX 1215/1225/1235)	⑦	CN2
③	DC output -	⑧	TEMP/CN3
④	DC output +	⑨	CN4
⑤	Dip Switch 1 (S1)		



Note: For detail description on item 5 (Dip Switch S1), please refer to section 3-2

2-3-2. CX1215 / 1225 / 1235 / 2415 (Rear Panel)

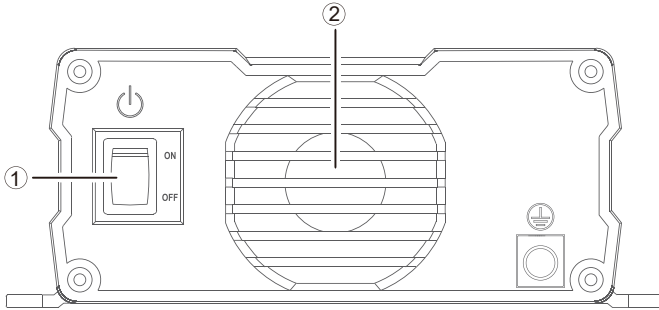

Figure 7. CX1215/1225/1235/2415 rear panel

Front panel			
①	AC Inlet (IEC)	②	Status LED

2-3-3. CX1250 / 1280 / 2425 / 2440 (Front Panel)

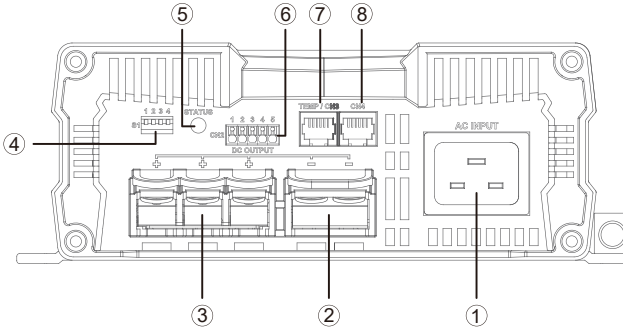

Figure 8. CX1250/1280/2425/2440 front panel

Front panel			
①	AC Inlet (IEC)	⑤	Status LED
②	DC output -	⑥	CN2
③	DC output +	⑦	TEMP/CN3
④	Dip Switch 1 (S1)	⑧	CN4



Note: For detail description on item 4 (Dip Switch S1), please refer to section 3-2

2-3-4. CX1250 / 1280 / 2425 / 2440 (Rear Panel)

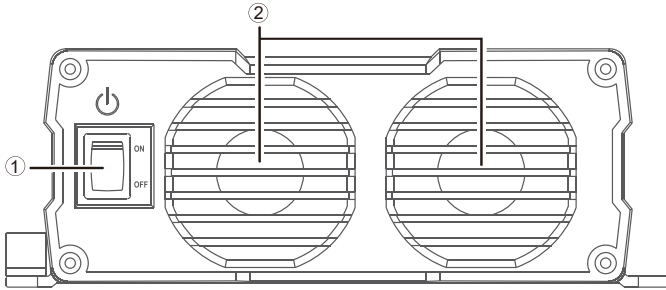

Figure 9. CX1250/1280/2425/2440 rear panel

Front panel	
①	Power Switch
②	Fan





3. Product Description

Below models are available with COTEK Advanced Battery Charger CX Series:

Model	No. of supply battery	Support ESB (Extra Second Battery)
CX1215	1	Yes
CX1225 / CX1235	2	Yes
CX1250 / CX1280	3	No
CX2415	2	No
CX2425 / CX2440	3	No

3-1. Configurations

3-1-1. Standard Accessory

Number	A	B	C	D
Description	Copper Bus		Screw	AC Power Cable
Diagram				

Quantity per	CX 1215	CX 1225	CX 1235	CX 1250	CX 1280	CX 2415	CX 2425	CX 2440
A	x	1pcs	1pcs	x	x	1pcs	x	x
B	x	x	x	1pcs	1pcs	x	1pcs	1pcs
C	x	2pcs	2pcs	3pcs	3pcs	2pcs	3pcs	3pcs
D	1pcs	1pcs	1pcs	1pcs	1pcs	1pcs	1pcs	1pcs

3-1-2. Optional Accessory

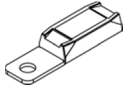
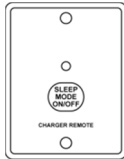
Number	A	B	C
Description	Ring Terminal	Battery Temp Sensor	Remote
Diagram			

Number	CX 1215	CX 1225	CX 1235	CX 1250	CX 1280	CX 2415	CX 2425	CX 2440
A	2pcs	3pcs	3pcs	5pcs	5pcs	3pcs	5pcs	5pcs
B	1pcs	1pcs	1pcs	1pcs	1pcs	1pcs	1pcs	1pcs
C	1pcs	1pcs	1pcs	1pcs	1pcs	1pcs	1pcs	1pcs

3-2. S1 Setting

3-2-1. Dip switch setting

Status	1	2	3	4	12V / 24V CC/CV	12V / 24V Float
CC turn to CV voltage	ON	X	OFF	X	14.4V / 28.8V	---
	OFF	X	OFF	X	14.7V / 29.4V	---
Float voltage	X	ON	OFF	X	---	13.5V / 27.0V
	X	OFF	OFF	X	---	13.8V / 27.6V
Power Mode (Current limit output voltage)	OFF	OFF	ON	X	13.2V / 26.4V	
	OFF	ON	ON	X	13.8V / 27.6V	
	ON	OFF	ON	X	14.4V / 28.8V	
Remote	ON	ON	ON	X	---	---
Sleep Mode	X	X	X	ON	---	---
	X	X	X	OFF	---	---

X: Not Applicable

---: By Default setting

3-2-2. Default setting

Model	12V Series	24V Series
CC/CV	14.4V	28.8V
Float	13.8V	27.6V
Power Mode	Off	Off
Remote	Off	Off
Fan	Full Speed	Full Speed

3-3. Charging Status LED Indicator

Charging status	LED Status	
Bulk-1	Orange fast	-----
Bulk-2	Orange slow	- - - - -
Absorption-1	Orange solid	=====
Absorption-2	Green solid	=====
Float	Green flash
	LED color change by the status change	

3-4. Failure Indicator

Failure status	LED Status		Description
Input or Output	Red solid	=====	Output current is reduced to <1A
			AC I/P unstable
			Output FUSE blown
Temperature	Red fast	-----	Battery over heat (the indicator is available only when COTEK temperature sensor is connected)
			Battery under heat (the indicator is available only when COTEK temperature sensor is connected)
			Charger over heat (Heat Sink)
Battery voltage	Red slow	- - - - -	Battery over voltage
			Battery under voltage or output under voltage in C.C. mode.
Fan abnormality	Red light flash twice	Fan abnormality
ESB Failure	Red slow every 2 sec.	- - - - -	ESB no output / output short

3-5. Pin Assignment of CN2 – For Alarms Signal & Fan Control

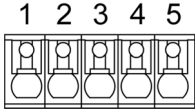
1	Normally closed	
2	Normally open	
3	COM	
4	Sleep mode control	
5	GND	

4-5 Short	Sleep mode on
4-5 Open	Sleep mode off

3-6. Sleep Mode

#	CR-1	CN2 ^{*1}	Sleep Mode	Fan Speed
A	OFF	OFF	OFF	Fan will operate according to heat sink temperature and loads condition
B	OFF	ON	ON	Fan operates at 50% duty
C	ON	ON	ON (deep sleep)	Fan stop
D	ON	OFF	ON (deep sleep)	Fan stop

After 8 hours to use CR-1^{*2} to start Sleep Mode, then the sleep mode will stop. Please use the CN2 to determine the Sleep Mode ON/OFF.

*1 : Please refer to 3-5.

*2 : CR-1 is the CX remote controller, and sleep mode can be set by this remote controller.

3-7. Pin Assignment of CN3 – For Temperature sensor & Remote control

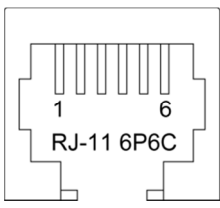
1	R_VCC	
2	GND	
3	TEMP	
4	BAT-	
5	DATA I/O	
6	NC.	

3-8. Pin Assignment of CN4 – For Remote control

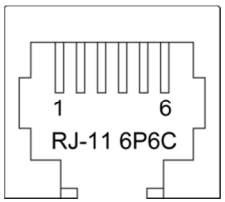
1	R_VCC	
2	BAT-	
3	NC.	
4	BAT-	
5	DATA I/O	
6	NC.	

3-9. Pin Assignment of ESB Connectors – For CX1215/1225/1235

+	VCC	
-	GND	

3-10. Temperature Compensation

- CX12XX series model

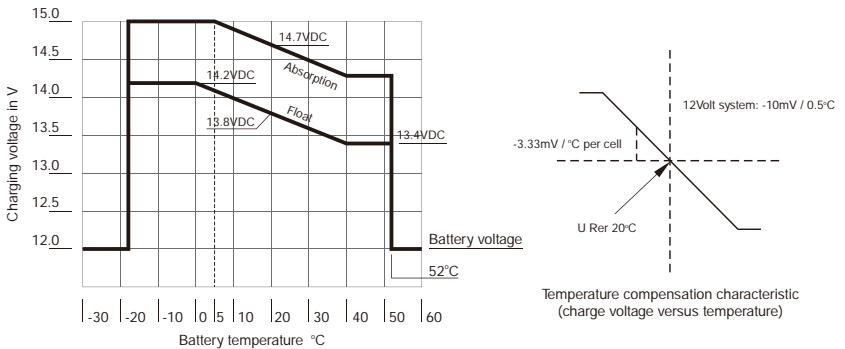

※ In the CV=14.7V and float=13.8V situation.
Please follow this rule in other situations.

Figure 10. CX12xx model Temperature Compensation

- CX24XX series model

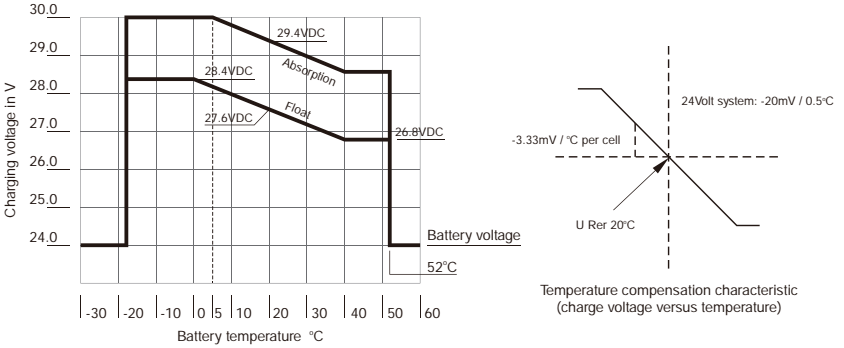

※ In the CV=29.4V and float=27.6V situation.
Please follow this rule in other situations.

Figure 11. CX24xx model Temperature Compensation

3-11. Rescue Battery Curve

In case of battery over discharge (when battery voltage lower than 10V), CX battery charger will reduce the charging current to prevent further damage on the battery.

The following curve is only applicable for Lead-acid & AGM battery.

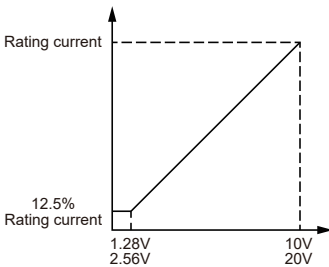

Figure 12. Lead-acid & AGM battery curve

3-12. Battery Charger Selection (Reference only)

- 12 Volt Battery

COTEK Model	Battery capacity range	Estimated charging time
CX1215	50~80Ah	6~24
CX1225	80~125Ah	6~24
CX1235	125~175Ah	6~24
CX1250	175~250Ah	6~24
CX1280	250~400Ah	6~24

The above suggested battery charger selection is based on battery capacity multiply 0.2~0.3. Example: 100Ah battery
 * $0.2 / 0.3 = 20A \sim 30A$ in this case please select CX1225.

- 24 Volt Battery

COTEK Model	Battery capacity range	Estimated charging time
CX2415	50~80Ah	6~24
CX2425	80~125Ah	6~24
CX2440	125~200Ah	6~24

The above suggested battery charger selection is based on battery capacity multiply 0.2~0.3. Example: 100Ah battery
 * $0.2 / 0.3 = 20A \sim 30A$ in this case please select CX2425.

3-13. Battery Voltage setting suggestion

- GEL TYPE (Max. Voltage of 14.1 / 28.2 Volt)
- AGM TYPE (Max. Voltage of 14.4 / 28.8 Volt)
- Lead-Acid (Max. Voltage of 14.8 / 29.6 Volt)

3-14. Fan speed duty description

The fan determined by load and heat sink temperature.

1. Fan speed 100%: comply with one of the following conditions
 - a. Load $\geq 75\%$
 - b. Load $\geq 50\%$ and heat sink temperature $\geq 50^{\circ}\text{C}$
 - c. Heat sink temperature $\geq 75^{\circ}\text{C}$
2. Fan speed duty 50%:
 - a. Heat sink temperature $\geq 67.5^{\circ}\text{C}$
or
 - b. Set CX to sleep mode by setting DIP4 (Refer to 3-2) when
 1. a, b, or c applies
3. Fan speed duty 0%:
 - a. Load $< 75\%$ and heat sink temperature $< 35^{\circ}\text{C}$
or
 - b. Sleep mode turned on by CR-1

4. Installing Converter / Charger

When selecting the installation location, observe the following instructions:

- Do not install the charger in following situations:
 - ✧ In wet environments
 - ✧ In dusty environments
 - ✧ In the vicinity of combustible materials
 - ✧ In areas where there is a danger of explosions
- The place of installation must be well ventilated. A ventilation system must be available for installations in small, enclosed space. The clearance around the device must be at least 25cm.
- The air inlet on the underside and the air outlet on the back of the device must remain clear.
- For ambient temperatures higher than 40 °C (such as in engine or heating compartments, or direct sunlight), the heat from the charger under load can lead to reduced output.
- The charger must be installed on a level and sufficiently sturdy surface.
- Do not install the charger in the same area as the batteries.
- Do not install the charger above batteries, because they can emit corrosive sulphur fumes that will damage the device.



Notice!

Before drilling any holes, make sure that no electrical cables or other parts of the vehicle can be damaged by drilling, sawing and filing.

For installation and mounting you will need the following tools:

- Pen for marking
- Drill bit set
- Drill
- Screwdriver

To secure the charger in place you will need:

- Machine bolts (M4) with washers and self-locking nuts or
- Self-tapping screws or wood screws

Fasten the charger as follow:

- Hold the charger against the installation location
- Mark the fastening points
- Fasten the charger with one screw through each hole in the holders

4-1. Battery charger connection diagram

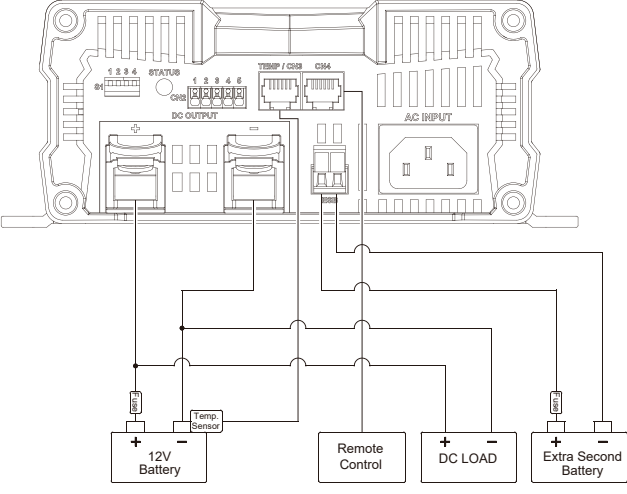
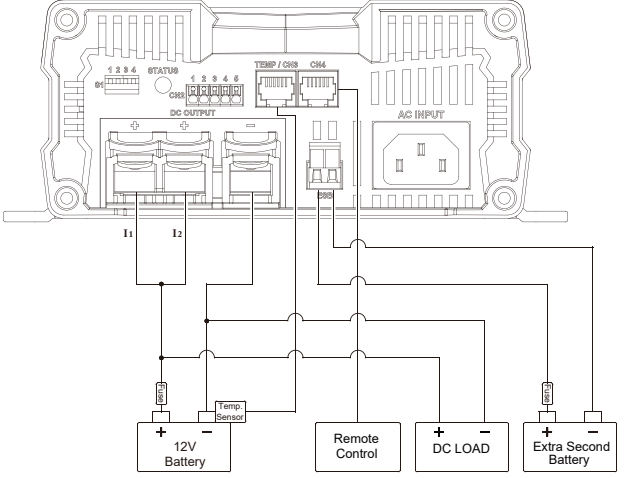
Model	Description	Connection diagram
<p>CX1215</p>	<p>15A MAX</p>	 <p>Fuse Voltage : 32V, Fuse Current : 23A</p>
<p>CX1225 CX1235</p>	<p>• I1+I2 CX1225 : 25A MAX CX1235 : 35A MAX</p>	 <p>CX1225 Fuse Voltage : 32V, Fuse Current : 40A CX1235 Fuse Voltage : 32V, Fuse Current : 50A</p>

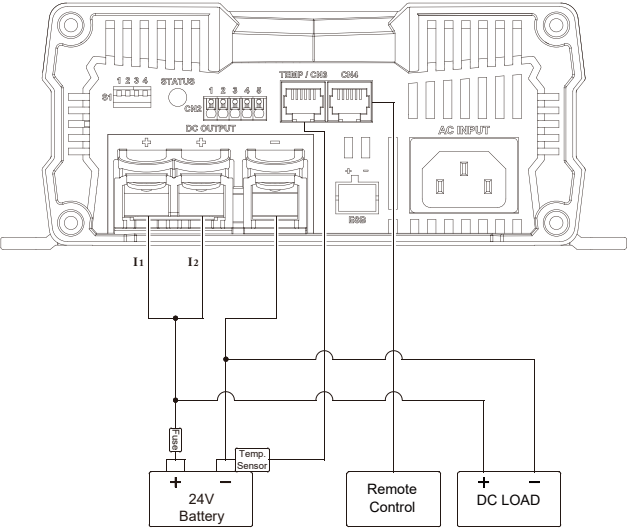
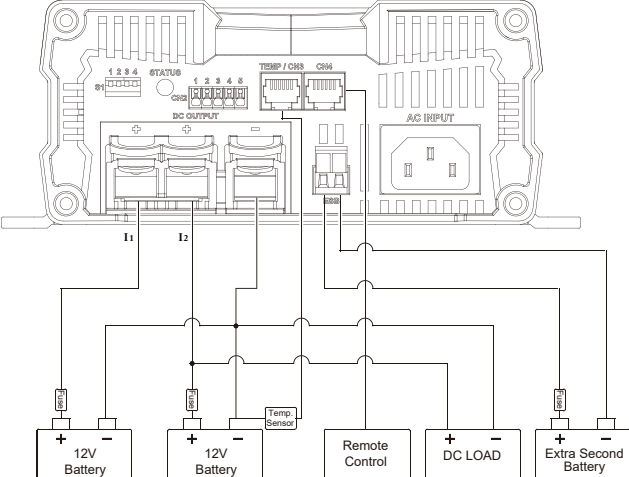
Model	Description	Connection diagram
<p>CX2415</p>	<p>• I1+I2 12.5A MAX</p>	 <p>Fuse Voltage : 32V, Fuse Current : 23A</p>
<p>CX1225 CX1235</p>	<p>• I1 or I2 CX1225 : 25A MAX CX1235 : 35A MAX</p>	 <p>CX1225 Fuse Voltage : 32V, Fuse Current : 40A CX1235 Fuse Voltage : 32V, Fuse Current : 50A</p>

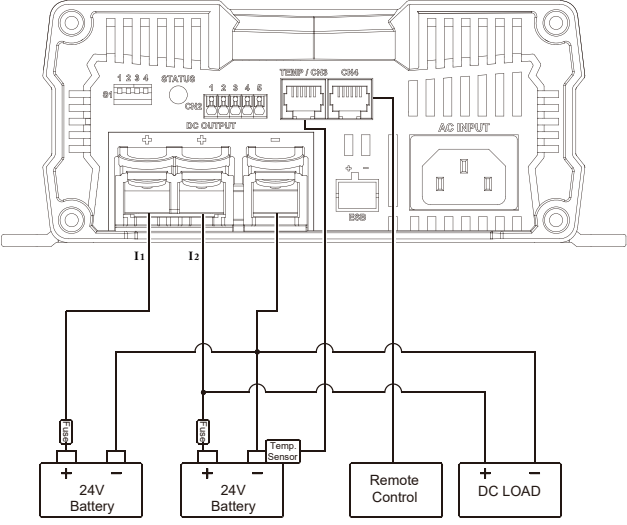
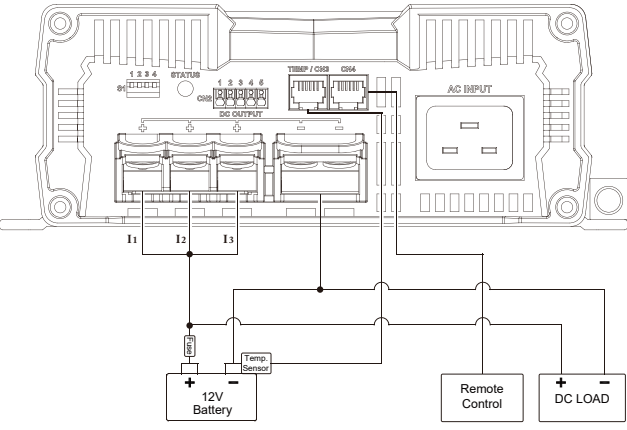
Model	Description	Connection diagram
<p>CX2415</p>	<p>• I1 or I2 12.5A MAX</p>	 <p>Fuse Voltage : 32V, Fuse Current : 23A</p>
<p>CX1250 CX1280</p>	<p>• I1+I2+I3 CX1250 : 50A MAX CX1280 : 80A MAX</p>	 <p>CX1250 Fuse Voltage : 32V, Fuse Current : 80A CX1280 Fuse Voltage : 32V, Fuse Current : 125A</p>

Model	Description	Connection diagram
<p>CX2425 CX2440</p>	<p>• I1+I2+I3 CX2425 : 25A MAX CX2440 : 40A MAX</p>	<p>CX2425 Fuse Voltage : 32V, Fuse Current : 40A CX2440 Fuse Voltage : 32V, Fuse Current : 80A</p>

5. Trouble Shooting

LED display	Cause	Remedy
Red, slowly flashing	Battery under voltage or battery overload	Check the battery. Switch the battery charger off and on again.
	Defective battery	Replace the battery
Red, rapidly flashing	Overheating	Improve the ventilation of the battery charger or battery. Make sure that no ventilation openings are covered. If necessary, reduce the ambient temperature.
Red, permanently lit	Short circuit or reversed polarity	Connect the battery charger with the correct polarity. Rectify the short circuit. Check if the fuse has blown and replace it if necessary.
Red, double flash	Fan fault	Check the fan for dirt or damage.
Red, slow, every 2 sec.	Fault at the starter battery connection	Check the starter battery connection for a short circuit.

6. Warranty Statement

6-1. Warning



Warning!

Do not open or disassemble the Converter / Charger. Attempting to do so may cause risk of electrical shock or fire.

6-2. Warranty

We guarantee this product against defects in materials and workmanship for a period of 24 months from the date of purchase. In case you need to repair or replace any defective power inverters, please contact COTEK local distributor.

This warranty will be considered void if the unit has been misused, altered, or accidentally damaged. COTEK is not liable for anything that occurs as a result of the user's fault.

Table des matières

1. INFORMATIONS IMPORTANTES, SECURITE	31
1-1. Précautions générales	31
1-2. Précautions avec les batteries	32
2. PRESENTATION	33
2-1. Courbes de charge	34
2-2. Caractéristiques	36
2-3. Schémas mécaniques	39
3. DESCRIPTION DU PRODUIT	43
3-1. Configurations	43
3-2. Paramètres interrupteur DIP S1	44
3-3. Témoin de charge (LED)	45
3-4. Témoin de défaut (LED)	45
3-5. Connecteur CN2 – Signal d’alarme & contrôle du ventilateur	46
3-6. Mode veille	46
3-7. Connecteur CN3 – Capteur de température et commande à distance	46
3-8. Connecteur CN4 – Commande à distance (R)	47
3-9. Sortie supplémentaire (batterie) – Modèles CX1215/1225/1235 uniquement	47
3-10. Compensation en température	47
3-11. Courbe de régénération	48
3-12. Choix d’un chargeur (pour info)	49
3-13. Paramètres tension batterie (suggestions)	49
3-14. Régime du ventilateur	50

4. INSTALLATION DU CHARGEUR	51
4-1. Connexions à la batterie	53
5. RECHERCHE DE PANNES	57
6. GARANTIE	58
6-1. Avertissement	58
6-2. Garantie	58

1. Informations importantes, sécurité



Avertissement !

Prendre le temps de lire et de comprendre les informations contenues dans ce manuel avant d'installer le chargeur série CX.

1-1. Précautions générales

- 1-1-1. Conçu pour être utilisé en intérieur, le chargeur CX ne doit pas être exposé à l'eau, à la condensation, à la neige ou à la poussière. Pour réduire les risques d'incendie, ne pas couvrir ni obstruer les orifices de ventilation.
- 1-1-2. Pour éviter les risques d'incendie ou de chocs électriques, assurez-vous que les câbles sont en bon état et de section suffisante.
- 1-1-3. Ne pas raccorder l'appareil à des batteries non rechargeables.
- 1-1-4. Déposer les branchements au réseau avant de brancher l'appareil à la batterie ou de le débrancher.
- 1-1-5. N'utiliser que le cordon CA avec connecteur CE pour raccorder le chargeur au réseau.
- 1-1-6. Ne jamais charger une batterie qui a gelé.
- 1-1-7. Ne jamais utiliser un cordon CA endommagé. Le remplacer ou le faire réparer par un professionnel.
- 1-1-8. Des substances corrosives risquant de s'échapper de la batterie, la charger ou la stocker dans un lieu adéquat.

1-2. Précautions avec les batteries

- 1-2-6. En cas de contact de l'électrolyte avec la peau ou les vêtements, laver immédiatement à l'eau savonneuse.
- 1-2-7. Si les yeux sont atteints, laver à l'eau courante pendant 20 minutes minimum et consulter immédiatement un médecin.
- 1-2-8. Ne jamais fumer, créer une étincelle ou utiliser une flamme à proximité de la batterie.
- 1-2-9. Ne pas laisser tomber d'objet métallique sur la batterie.
L'étincelle ou le court-circuit ainsi provoqué pourrait entraîner une explosion.
- 1-2-10. Ne pas porter d'objets métalliques tels que bagues, bracelets, colliers ou montres lorsque vous intervenez sur des batteries plomb-acide. Le courant de court-circuit produit par ce type de batterie est suffisamment important pour faire fondre une bague ou un objet métallique de ce type, ce qui entraînerait une brûlure sévère.

2. Présentation

- Entrée CA universelle avec correction active du facteur de puissance (PFC)
- Compatible avec les batteries plomb-acide, Li-ion, Gel et AGM
- Peut être utilisé avec une commande à distance type CR-1 (option)
- Compensation en tension / en température
- Ventilateur 2 vitesses (mode veille)
- Témoin sortie CA active
- Alarme sortie CA
- Haut rendement et grande fiabilité
- Fonction intégrée de restauration de la batterie
- Sortie batterie supplémentaire (ESB)
- Protections : court-circuit / surtension / surchauffe / chute de tension
- Résiste à des tests de vibrations de 2 G

2-1. Courbes de charge



Schéma 1. Chargeur série CX – Courbes de charge

2-1-1. Phase de Boost – Bulk Stage (courant constant)

Au début du cycle de charge, la batterie à plat est chargée à courant constant (au courant de charge max), jusqu'à ce que la tension atteigne le seuil de fin de phase (voir § 3-2-1 Paramètres).

2-1-2. Phase d'absorption – Absorption Stage (tension constante)

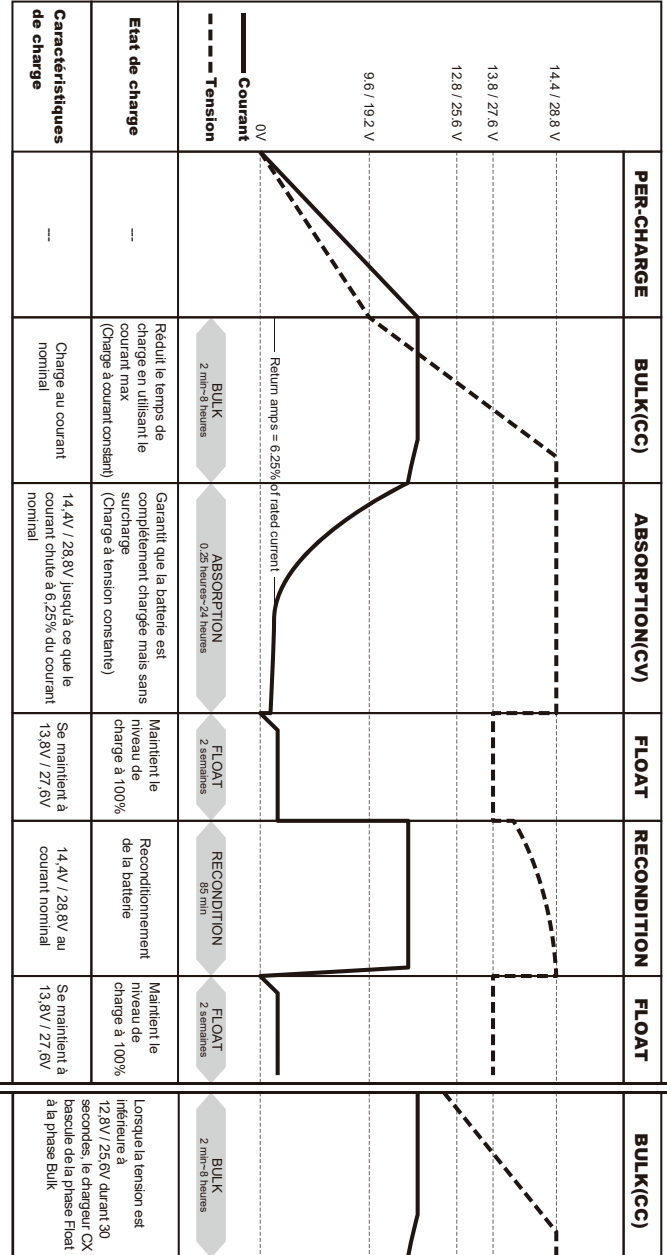
La durée d'absorption dépend de l'état de la batterie.

Il y a une temporisation de 2 minutes avant que le chargeur ne bascule en phase d'absorption. Durant cette phase il charge la batterie à tension constante jusqu'à ce qu'elle soit complètement rechargée.

Lorsque la batterie est complètement rechargée ou lorsque le courant de charge est inférieur à 6,25% du courant nominal durant 15 minutes, la phase d'absorption se termine.

2-1-3. Phase d'entretien – Float Stage

À l'issue de la phase d'absorption, le chargeur bascule en phase d'entretien, pour maintenir la charge à 100 % mais sans risques de surcharge ou de dommages pour la batterie. Ce qui veut dire que le chargeur peut rester connecté à la batterie en continu.

2-1-4. Phase de reconditionnement – Recondition Stage

Tous les 14 jours, le chargeur entretient la batterie en effectuant une charge de Boost durant 85 minutes. Cela permet notamment de prévenir les risques de sulfatation.

2-2. Caractéristiques

Modèle		CX1215	CX1225	CX1235	CX1250	CX1280
Sortie	Type de batterie	Plomb-acide / Li-ion / Gel / AGM				
	Tension de Boost	14.4 V / 14.7 V (choix via interrupteur DIP S1)				
	Tension d'entretien (Float)	13.8 V / 13.5 V (choix via interrupteur DIP S1)				
	Courant nominal	15 A	25 A	35 A	50 A	80 A
	Sortie(s)	1	2	2	3	3
	Sortie supplémentaire (ESB)	1	1	1	--	--
	Tension/Courant sortie suppl.	13.8 V / 2 A	13.8 V / 2 A	13.8 V / 2 A	--	--
	Algorithme de charge	3 phases de charge IUOU				
	Type d'isolation	Transistor à effet de champ (MOSFET) sur chaque sortie				
Courant max par sortie	15 A	25 A	35 A	40 A	40 A	
Entrée	Tension nominale	100 V CA ~ 240 V CA (100 V CA ~ 120 V CA sur modèles UL458)				
	Plage tensions admissibles	90 V CA ~ 264 V CA (90 V CA - 132 V CA sur modèles UL458) (Voir 2-2-2 courbe de déclassement)				
	Plage fréquences admissibles	47 Hz ~ 63 Hz				
	Facteur de puissance (Type)	> 0.92 à pleine charge				
	Rendement (Type) à 230 V CA	87 %	87 %	87 %	87 %	87 %
Protections	Court-circuit	Réduction du courant < 1 A continu durant 30 secondes, actif 30 secondes avant arrêt de l'appareil				
	Surtension	17.5 V \pm 1 %, type de protection : désactivation de la sortie (réactivation lorsque le réseau est rétabli)				
	Surchauffe	Arrêt lorsque la température (dissipateur) est > 100°C \pm 5°C				
		52°C \pm 5°C (capteur de température en option) Redémarrage automatique lorsque la température redescend à 50°C \pm 5°C				
Fonctions	Signal d'alarme	Via un relais NF/NO (Voir § 3-5)				
	Compensation en température	12 V : -10 mV / 0.5°C avec capteur de température COTEK 24 V : -20 mV / 0.5°C avec capteur de température COTEK				
	Mode veille	Via commande à distance ou interrupteur DIP S1-4 (Voir § 3-2)				
	Commande à distance	Compatible avec commande COTEK CR-1 (Voir § 3-6 et 3-7)				
Environnement	Plage températures, fonctionnement	-20°C ~ +40°C (Voir § 2-2-1 Courbe de déclassement)				
	Plage humidité, fonctionnement	20 % ~ 90% (humidité relative, sans condensation)				
	Coefficient de compensation en T°	\pm 0.03 % (0°C ~ 50°C)				
	Vibrations	10 Hz ~ 500 Hz, 2 G 10 minutes / 1 cycle de 60 minutes sur les 3 axes X, Y, Z				
Sécurité & CEM	Normes, sécurité	EN 60335-1, EN 60335-2-29, UL458 (CX1235/1250/1280 uniquement)				
	Tension de tenue	I/P-O/P: 4242VDC, I/P-FG: 1768VDC, O/P-FG: 707VDC				
	Résistance d'isolement	I/P-O/P: 100M Ohms / 500VDC				
	Normes, CEM	EN 55022: EN 61204-3; EN 55014-1 EN 61000-3-2; EN 61000-3-3; EN 61204-3; EN 61000-6-3 EN 55024; IEC 61000-4-2, 3, 4, 5, 6, 8, 11; ENV 50204; EN 61000-6-1; EN 55014-2				
Autres	Dimensions (xHxP)	183x72x243mm		183x72x263mm	213x77x272mm	213x77x312mm
	Poids emballé	1.6 kg	1.7 kg	1.9 kg	3.1 kg	4.0 kg

Modèle		CX2415	CX2425	CX2440
Sortie	Type de batterie	Plomb-acide / Li-ion / Gel / AGM		
	Tension de Boost	28.8 V / 29.4 V (choix via interrupteur DIP S1)		
	Tension d'entretien (Float)	27.6 V / 27 V (choix via interrupteur DIP S1)		
	Courant nominal	12.5 A	25 A	40 A
	Sortie(s) CA	2	3	3
	Sortie supplémentaire (ESB)	--	--	--
	Tension/Courant sortie suppl.	--	--	--
	Algorithme de charge	3 phases de charge IUOU		
	Type d'isolation	Transistor à effet de champ (MOSFET) sur chaque sortie		
	Courant max par sortie	12.5 A	25 A	40 A
Entrée	Tension nominale	100 V CA ~ 240 V CA (100 V CA ~ 120 V CA sur modèles UL458)		
	Plage tensions admissibles	90 V CA ~ 264 V CA (90 V CA ~ 132 V CA sur modèles UL458) (Voir § 2-2-2 Courbe de déclassement)		
	Plage fréquences admissibles	47 Hz ~ 63 Hz		
	Facteur de puissance (Type)	> 0.92 à pleine charge		
	Rendement (Type) à 230 V CA	90 %	90 %	90 %
Protection	Court-circuit	Réduction du courant < 1 A en continu durant 30 secondes, actif 30 secondes avant arrêt de l'appareil		
	Surtension	35 V ± 1 %, type de protection : désactivation de la sortie (réactivation lorsque le réseau est rétabli)		
	Surchauffe	Arrêt lorsque la température (dissipateur) est > 100°C ± 5°C		
		52°C ± 5°C (capteur de température en option)		
		Redémarrage automatique lorsque la température redescend à 50°C ± 5°C		
Fonctions	Signal d'alarme	Via un relais NF/NO (Voir § 3-5)		
	Compensation en température	12 V : -10 mV / 0.5°C avec capteur de température COTEK		
		24 V : -20 mV / 0.5°C avec capteur de température COTEK		
	Mode veille	Via commande à distance ou interrupteur DIP S1-4 (Voir § 3-2)		
Commande à distance	Compatible avec commande COTEK CR-1 (Voir § 3-6 et 3-7)			
Environnement	Plage températures, fonctionnement	-20°C ~ +40°C (Voir § 2-2-1 Courbe de déclassement)		
	Plage humidité, fonctionnement	20 % ~ 90 % (humidité relative, sans condensation)		
	Coefficient de compensation T°	± 0.03 % (0°C ~ 50°C)		
	Vibrations	10 Hz ~ 500 Hz, 2 G 10 minutes / 1 cycle de 60 minutes sur les 3 axes X, Y, Z		
Sécurité & CEM	Normes, sécurité	EN 60335-1, EN 60335-2-29, UL458 (CX2425/2440 uniquement)		
	Tension de tenue	I/P-O/P: 4242VDC, I/P-FG: 1768VDC, O/P-FG: 707VDC		
	Résistance d'isolement	I/P-O/P: 100M Ohms / 500VDC		
	Normes, CEM	EN 55022; EN 61204-3; EN 55014-1 EN 61000-3-2; EN 61000-3-3; EN 61204-3; EN 61000-6-3 EN 55024; IEC 61000-4-2, 3, 4, 5, 6, 8, 11; ENV 50204; EN 61000-6-1; EN 55014-2		
Autres	Dimensions (LxHxP)	183x72x243 mm	213x77x272 mm	213x77x312 mm
	Poids emballé	1.6 kg	2.9 kg	3.9 kg

2-2-1. Courant de charge vs température ambiante – Courbe de déclassement



Schéma 2. Courant de charge vs température ambiante – Courbe de déclassement

2-2-2. Courant de charge vs tension d'entrée – Courbe de déclassement

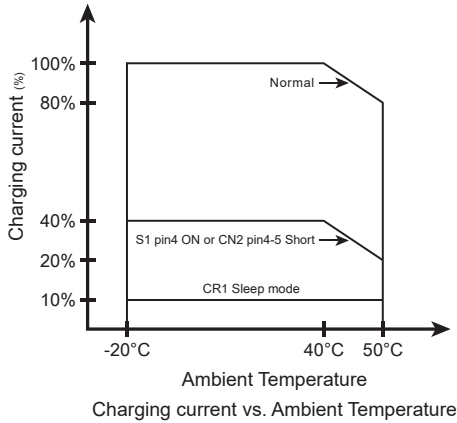

Schéma 3. Courant de charge vs tension d'entrée – Courbe de déclassement

2-3. Schémas mécaniques

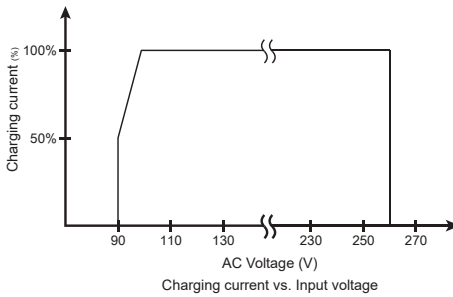

Schéma 4. Schémas mécaniques

Modèle	A (mm)	B (mm)	C (mm)	D (mm)	E (mm)	F (mm)
CX1215	243	54.2	135.0	183	6.5	72
CX1225	243	54.2	135.0	183	6.5	72
CX1235	263	56.7	150.0	183	6.5	72
CX1250	272	60.2	152.0	213	6.5	77
CX1280	312	65.2	182.0	213	6.5	77
CX2415	243	54.2	135.0	183	6.5	72
CX2425	272	60.2	152.0	213	6.5	77
CX2440	312	65.2	182.0	213	6.5	77

2-3-1. CX1215 / 1225 / 1235 / 2415 (Panneau avant)

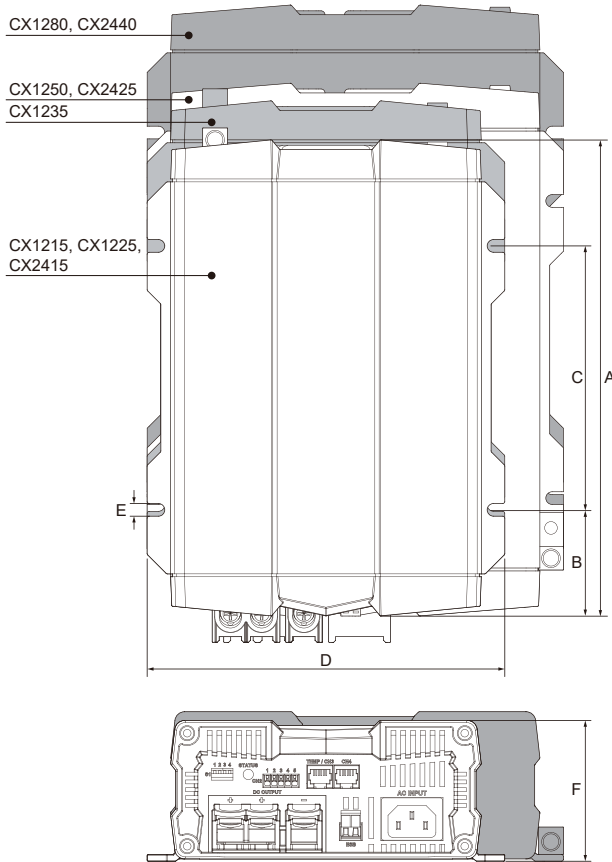

Schéma 5. CX1215 – Panneau avant



Schéma 6. CX1225/1235/2415 – Panneau avant

Panneau avant			
①	Entrée CA (IEC)	⑥	Témoin d'état (LED)
②	Sortie supplémentaire (sur CX 1215/1225/1235)	⑦	CN2
③	Négatif sortie CC (-)	⑧	TEMP/CN3
④	Positif sortie CC (+)	⑨	CN4
⑤	Interrupteur DIP 1 (S1)		

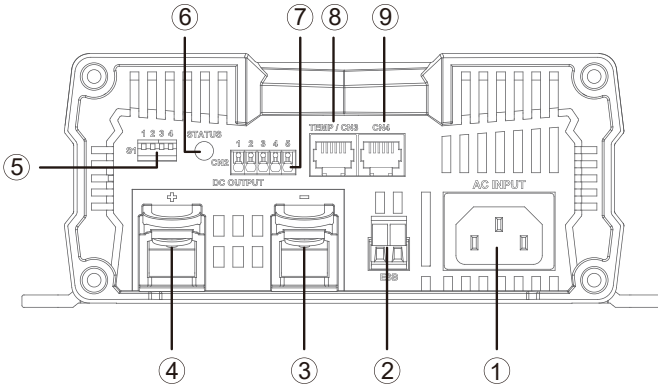

Note: pour une description détaillée de l'interrupteur DIP S1, voir § 3-2.

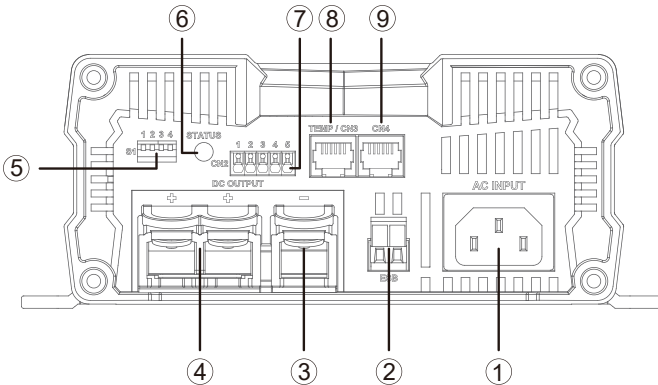
2-3-2. CX1215 / 1225 / 1235 / 2415 (Panneau arrière)



Schéma 7. CX1215/1225/1235/2415 – Panneau arrière

Panneau arrière			
①	Entrée CA (IEC)	②	Témoin d'état (LED)

2-3-3. CX1250 / 1280 / 2425 / 2440 (Panneau avant)

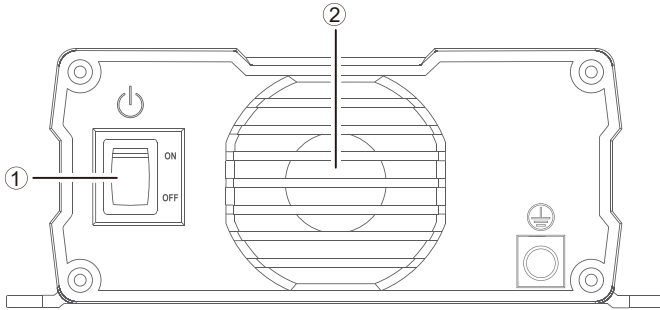

Schéma 8. CX1250/1280/2425/2440 – Panneau avant

Panneau avant			
①	Entrée CA (IEC)	⑤	Témoin d'état (LED)
②	Négatif sortie CC (-)	⑥	CN2
③	Positif sortie CC (+)	⑦	TEMP/CN3
④	Interrupteur DIP 1 (S1)	⑧	CN4

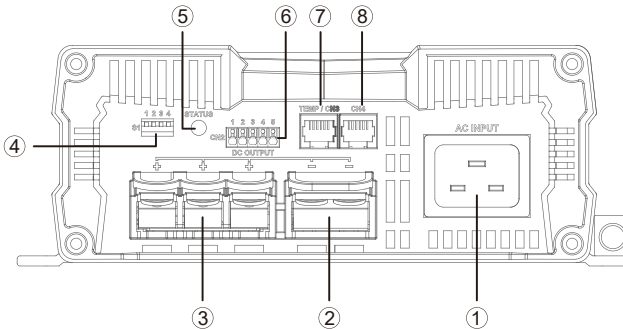

Note: pour une description détaillée de l'interrupteur DIP S1, voir § 3-2.

2-3-4. CX1250 / 1280 / 2425 / 2440 (Panneau arrière)



Schéma 9. CX1250/1280/2425/2440 – Panneau arrière

Panneau arrière			
①	Interrupteur Marche/Arrêt	②	Ventilateur



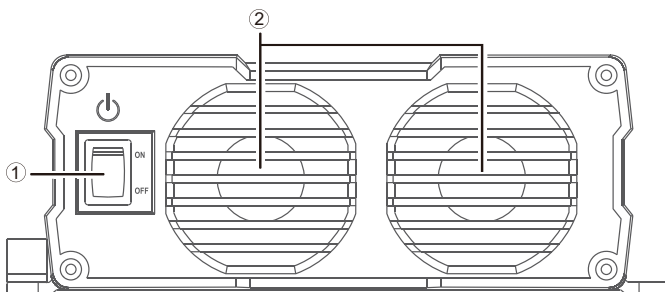

3. Description du produit

Étendue de la gamme de chargeurs COTEK série CX :

Modèle	Nb de sortie(s)	Sortie supplémentaire (ESB)
CX1215	1	Oui
CX1225 / CX1235	2	Oui
CX1250 / CX1280	3	Non
CX2415	2	Non
CX2425 / CX2440	3	Non

3-1. Configurations

3-1-1. Accessoires en standard

Repère	A	B	C	D
Description	Connecteur cuivre		Vis	Câble alim. CA
Schéma				

Quantités	CX 1215	CX 1225	CX 1235	CX 1250	CX 1280	CX 2415	CX 2425	CX 2440
A	x	1	1	x	x	1	x	x
B	x	x	x	1	1	x	1	1
C	x	2	2	3	3	2	3	3
D	1	1	1	1	1	1	1	1

3-1-2. Accessoires en option

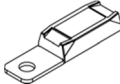
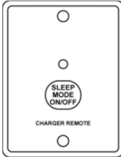
Repère	A	B	C
Description	Cosse	Capteur T° batterie	Cde à distance
Schéma			

Quantités	CX 1215	CX 1225	CX 1235	CX 1250	CX 1280	CX 2415	CX 2425	CX 2440
A	2	3	3	5	5	3	5	5
B	1	1	1	1	1	1	1	1
C	1	1	1	1	1	1	1	1

3-2. Paramètres interrupteur DIP S1

3-2-1. Paramètres

État	1	2	3	4	12 V / 24 V Seuil CC/CV	12 V / 24 V Float
Basculement charge CC/CV*	ON	X	OFF	X	14.4 V / 28.8 V	---
	OFF	X	OFF	X	14.7 V / 29.4 V	---
Tension de Float	X	ON	OFF	X	---	13.5 V / 27.0 V
	X	OFF	OFF	X	---	13.8 V / 27.6 V
Mode alimentation (courant limité)	OFF	OFF	ON	X	13.2 V / 26.4 V	
	OFF	ON	ON	X	13.8 V / 27.6 V	
	ON	OFF	ON	X	14.4 V / 28.8 V	
Cde à distance	ON	ON	ON	X	---	---
Mode veille	X	X	X	ON	---	---
	X	X	X	OFF	---	---

* : CC : courant constant – CV : tension constante

X : non applicable

--- : paramètre par défaut

3-2-2. Paramètres par défaut

Modèle	12 V	24 V
Seuil basculement charge CC/CV*	14.4 V	28.8 V
Tension de Float	13.8 V	27.6 V
Mode alimentation	Off	Off
Commande à distance	Off	Off
Ventilateur	Vitesse max.	Vitesse max.

3-3. Témoin de charge (LED)

Phase	État de la LED	
Bulk-1	Orange, flashes rapides	-----
Bulk-2	Orange, flashes lents	- - - - -
Absorption-1	Orange, fixe	=====
Absorption-2	Vert, fixe	=====
Float	Vert, flashes
	La couleur de la LED varie en fonction de la phase en cours	

3-4. Témoin de défaut (LED)

Défaut	État de la LED		Description
Entrée ou Sortie	Rouge, fixe	=====	Réduction du courant < 1 A
			Entrée CA instable
			Le fusible a sauté (sortie)
Température	Rouge, fixe	-----	Surchauffe batterie (le témoin ne fonctionne que lorsque le capteur COTEK a été installé)
			Batterie trop froide (le témoin ne fonctionne que lorsque le capteur COTEK a été installé)
			Surchauffe chargeur (dissipateur)
Tension batterie	Rouge, flashes lents	- - - - -	Surtension
			Sous-tension batterie en phase de charge à courant constant
Ventilateur	Rouge, flashes doubles	Ventilateur en défaut
Sortie supplémentaire	Rouge, flashes toutes les 2 s.	- - - - -	Pas de courant sur la sortie / court-circuit

3-5. Connecteur CN2 – Signal d’alarme & contrôle du ventilateur

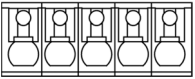
1	Normalement fermé	
2	Normalement ouvert	
3	COM	
4	Contrôle mode veille	
5	Terre	

4-5 avec cavalier	Mode veille activé (ON)
4-5 sans cavalier	Mode veille désactivé (OFF)

3-6. Mode veille

#	CR-1	CN2*1	Mode veille	Ventilateur
A	OFF	OFF	OFF	Ventilateur asservi à la température (dissipateur) et à la charge
B	OFF	ON	ON	Ventilateur à ½ régime
C	ON	ON	ON (veille profonde)	Ventilateur arrêté
D	ON	OFF	ON (veille profonde)	Ventilateur arrêté

*1 : voir § 3-5. La commande à distance CR-1 peut être utilisée pour mettre le chargeur en veille. Il en sortira au bout de huit heures. Sinon, utiliser CN2 pour paramétrer le mode veille (ON/OFF).

3-7. Connecteur CN3 – Capteur de température et commande à distance

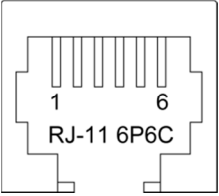
1	R_VCC (Positif VCC)	
2	GND (terre)	
3	TEMP (température)	
4	BAT- (négatif batterie)	
5	DATA I/O (entrée/sortie des données)	
6	NC (contact NF)	

3-8. Connecteur CN4 – Commande à distance (R)

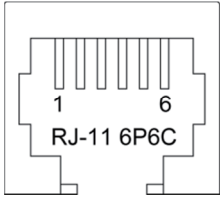
1	R_VCC (Positif VCC)	
2	BAT- (négatif batterie)	
3	NC (contact normalement fermé)	
4	BAT- (négatif batterie)	
5	DATA I/O (entrée/sortie des données)	
6	NC (contact normalement fermé)	

3-9. Sortie supplémentaire (batterie) – Modèles CX1215/1225/1235 uniquement

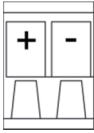
+	VCC (Positif VCC)	
-	GND (terre)	

3-10. Compensation en température

- Modèles CX12XX

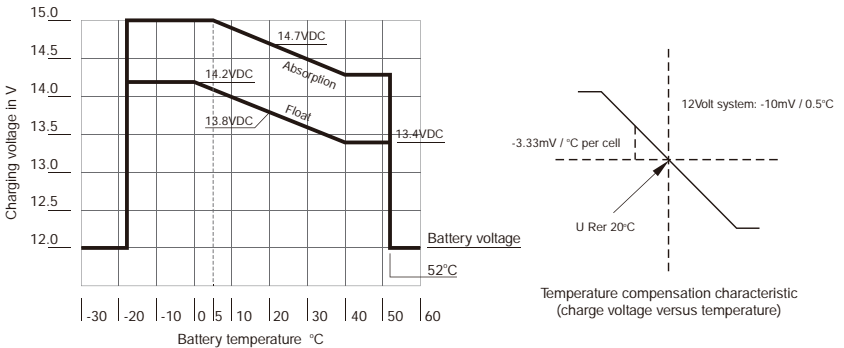

※ In the CV=14.7V and float=13.8V situation.
Please follow this rule in other situations.

Schéma 10. Compensation en température sur les modèles CX12xx

- Modèles CX24XX

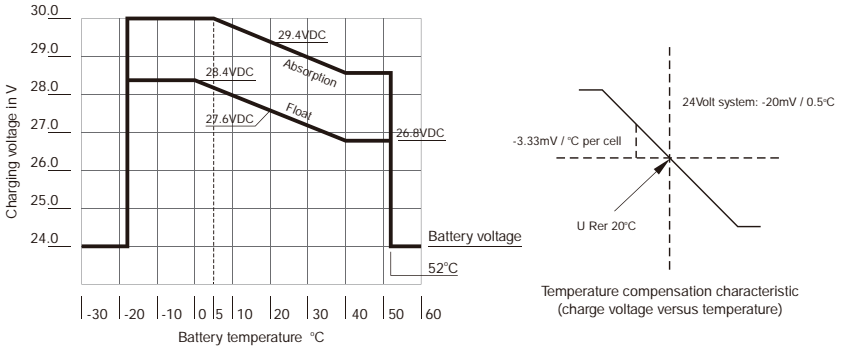

※ In the CV=29.4V and float=27.6V situation.
Please follow this rule in other situations.

Schéma 11. Compensation en température sur les modèles CX24xx

3-11. Courbe de régénération

En cas de décharge profonde (tension batterie < 10 V), le chargeur CX réduit le courant de charge pour ne pas endommager davantage la batterie.

La courbe suivante ne s'applique qu'aux batteries plomb-acide et AGM.



Schéma 12. Courbe de régénération

3-12. Choix d'un chargeur (pour info)

- Batterie 12 V

Chargeur	Capacité de la batterie	Estimation du temps de charge
CX1215	50~80 A.h	6~24
CX1225	80~125 A.h	6~24
CX1235	125~175 A.h	6~24
CX1250	175~250 A.h	6~24
CX1280	250~400 A.h	6~24

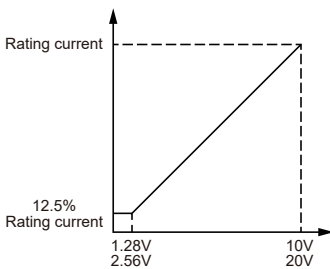
Pour cette estimation nous avons multiplié la capacité par 0.2~0.3. Exemple pour une batterie 100 A.h :

$100 \times 0.2 / 0.3 = 20 \text{ A} \sim 30 \text{ A}$, choisir le modèle CX1215.

- Batterie 24 V

Chargeur	Capacité de la batterie	Estimation du temps de charge
CX2415	50~80 A.h	6~24
CX2425	80~125 A.h	6~24
CX2440	125~200 A.h	6~24

Pour cette estimation nous avons multiplié la capacité par 0.2~0.3. Exemple pour une batterie 100 A.h :

$100 \times 0.2 / 0.3 = 20 \text{ A} \sim 30 \text{ A}$, choisir le modèle CX2415.

3-13. Paramètres tension batterie (suggestions)

- GEL (tension max : 14.1 / 28.2 Volt)
- AGM (tension max : 14.4 / 28.8 Volt)
- Plomb-acide (tension max : 14.8 / 29.6 Volt)

3-14. Régime du ventilateur

Le ventilateur est asservi à la charge et à la température (dissipateur).

1. Plein régime (100%) :
 - a. Charge $\geq 75\%$
 - b. Charge $\geq 50\%$ et température du dissipateur $\geq 50^{\circ}\text{C}$
 - c. Température du dissipateur $\geq 75^{\circ}\text{C}$
2. $\frac{1}{2}$ régime (50%) :
 - a. Température du dissipateur $\geq 67.5^{\circ}\text{C}$
ou
 - b. Le chargeur CX bascule en mode veille en fonction de la configuration du DIP4 (voir § 3-2) lorsque 1. a, b, or c survient
3. Arrêt (0%) :
 - a. Charge $< 75\%$ et température du dissipateur $< 35^{\circ}\text{C}$
ou
 - b. Commande de mise en veille via la commande à distance CR-1

4. Installation du chargeur

Tenir compte des points suivants pour le choix de l'emplacement :

- Ne pas installer le chargeur:
 - ✧ Dans un environnement humide
 - ✧ Dans un environnement exposé à des poussières
 - ✧ À proximité de matériaux inflammables
 - ✧ Dans un environnement présentant des risques d'explosion
- L'emplacement choisi doit être correctement aéré. En lieu clos, prévoir un système de ventilation. Prévoir un dégagement minimum de 25 cm tout autour de l'appareil.
- L'entrée d'air sur le dessous de l'appareil et la sortie sur l'arrière ne doivent jamais être obstrués.
- Une température ambiante supérieure à 40°C (compartiment moteur, exposition au rayonnement solaire...), peut entraîner une baisse de performances.
- Le chargeur doit être monté à plat sur un support suffisamment résistant.
- Ne pas monter le chargeur à proximité des batteries.
- Ne pas monter le chargeur au-dessus des batteries car il risquerait d'être endommagé par les émanations corrosives qu'elles peuvent émettre.



Important !

Avant de fixer le chargeur, s'assurer que le montage ne risque pas d'endommager des câbles ou autres équipements sous le support choisi.

Prévoir les outils suivants :

- Marqueur
- Jeu de forets
- Perceuse
- Tournevis

Quincaillerie :

- Écrous M4 avec rondelle et écrous autobloquants ou
- Vis auto-taraudeuses ou vis à bois

Monter le chargeur de la manière suivante :

- Poser le chargeur à l'emplacement choisi
- Utiliser les orifices pour marquer les trous de fixation
- Utiliser des vis ou boulons adéquats en fonction de la nature du support

4-1. Connexions à la batterie

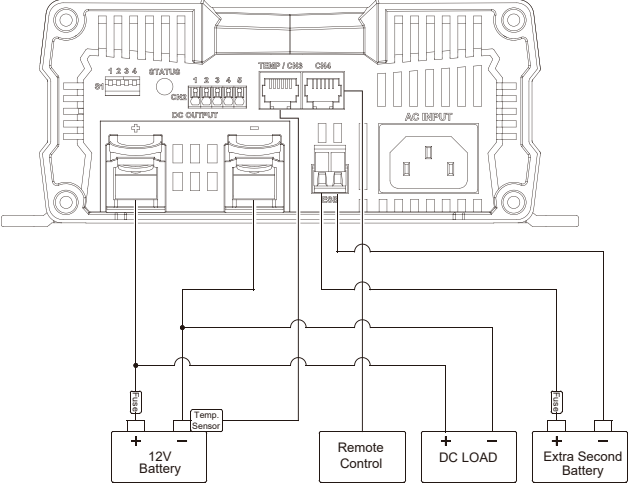
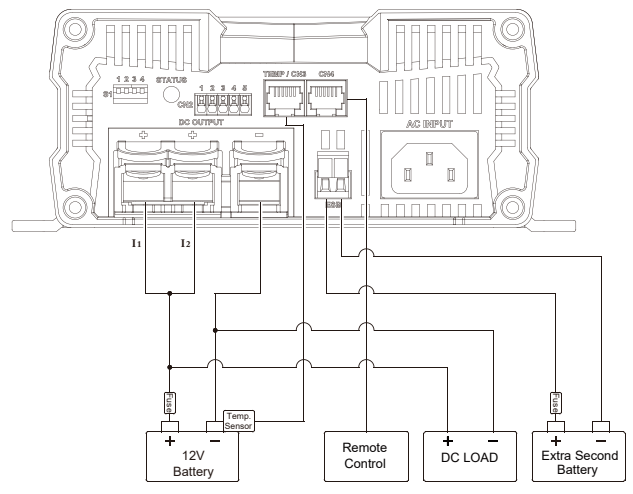
Modèle	Description	Schéma de câblage
<p>CX1215</p>	<p>15 A max</p>	 <p>The diagram shows a top-down view of the device's internal terminal block. On the left, there are four terminals labeled 1, 2, 3, and 4. Terminal 1 is connected to the positive (+) terminal of a 12V Battery. Terminal 2 is connected to the negative (-) terminal of the 12V Battery. Terminal 3 is connected to the positive (+) terminal of a Remote Control. Terminal 4 is connected to the negative (-) terminal of the Remote Control. In the center, there are four terminals labeled 1, 2, 3, and 4. Terminal 1 is connected to the positive (+) terminal of a DC LOAD. Terminal 2 is connected to the negative (-) terminal of the DC LOAD. Terminal 3 is connected to the positive (+) terminal of an Extra Second Battery. Terminal 4 is connected to the negative (-) terminal of the Extra Second Battery. On the right, there are four terminals labeled 1, 2, 3, and 4. Terminal 1 is connected to the positive (+) terminal of a 12V Battery. Terminal 2 is connected to the negative (-) terminal of the 12V Battery. Terminal 3 is connected to the positive (+) terminal of a Remote Control. Terminal 4 is connected to the negative (-) terminal of the Remote Control. A Temp. Sensor is connected to the TEMP / CH3 terminal. A DC OUTPUT terminal is also shown.</p> <p>Fusible : 32 V 23 A</p>
<p>CX1225 CX1235</p>	<p>I1+I2 CX1225 : 25 A max CX1235 : 35 A max</p>	 <p>The diagram shows a top-down view of the device's internal terminal block. On the left, there are four terminals labeled 1, 2, 3, and 4. Terminal 1 is connected to the positive (+) terminal of a 12V Battery. Terminal 2 is connected to the negative (-) terminal of the 12V Battery. Terminal 3 is connected to the positive (+) terminal of a Remote Control. Terminal 4 is connected to the negative (-) terminal of the Remote Control. In the center, there are four terminals labeled 1, 2, 3, and 4. Terminal 1 is connected to the positive (+) terminal of a DC LOAD. Terminal 2 is connected to the negative (-) terminal of the DC LOAD. Terminal 3 is connected to the positive (+) terminal of an Extra Second Battery. Terminal 4 is connected to the negative (-) terminal of the Extra Second Battery. On the right, there are four terminals labeled 1, 2, 3, and 4. Terminal 1 is connected to the positive (+) terminal of a 12V Battery. Terminal 2 is connected to the negative (-) terminal of the 12V Battery. Terminal 3 is connected to the positive (+) terminal of a Remote Control. Terminal 4 is connected to the negative (-) terminal of the Remote Control. A Temp. Sensor is connected to the TEMP / CH3 terminal. A DC OUTPUT terminal is also shown. Two additional terminals, I1 and I2, are located between the left and center terminal blocks. Terminal I1 is connected to the positive (+) terminal of a 12V Battery. Terminal I2 is connected to the negative (-) terminal of the 12V Battery.</p> <p>CX1225 - Fusible : 32 V 40 A CX1235 - Fusible : 32 V 50 A</p>

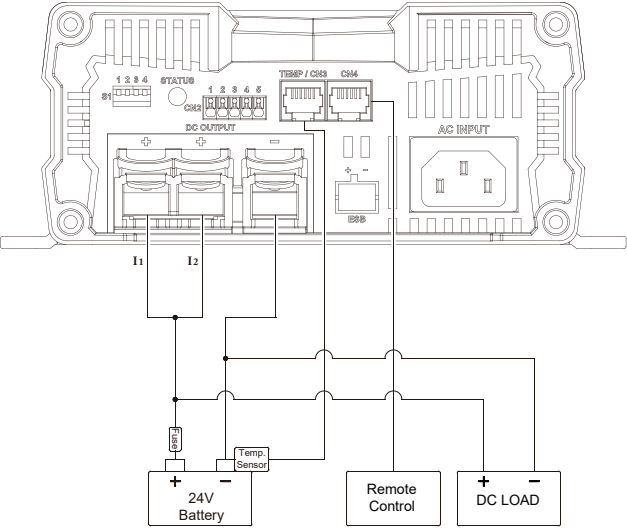
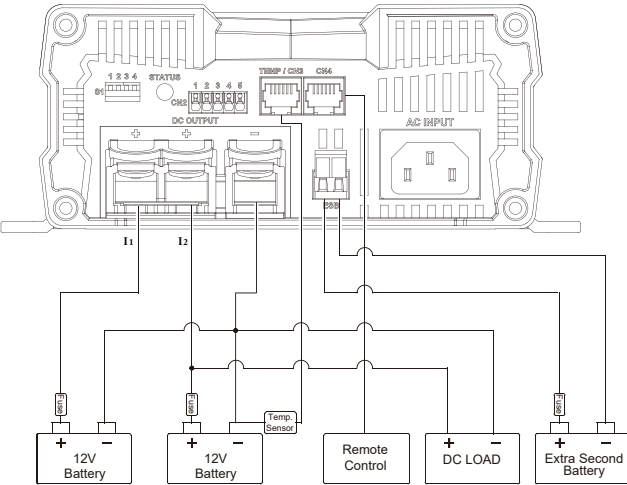
Modèle	Description	Schéma de câblage
CX2415	I1+I2 12.5 A max	 <p data-bbox="428 778 658 805">Fusible : 32 V 23 A</p>
CX1225 CX1235	I1 ou I2 CX1225 : 25 A max CX1235 : 35 A max	 <p data-bbox="428 1340 772 1367">CX1225 - Fusible : 32V 40 A</p> <p data-bbox="428 1372 772 1399">CX1235 - Fusible : 32 V 50A</p>

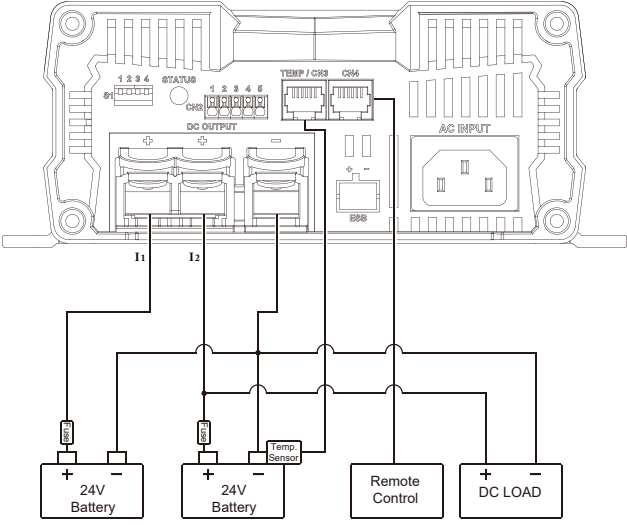
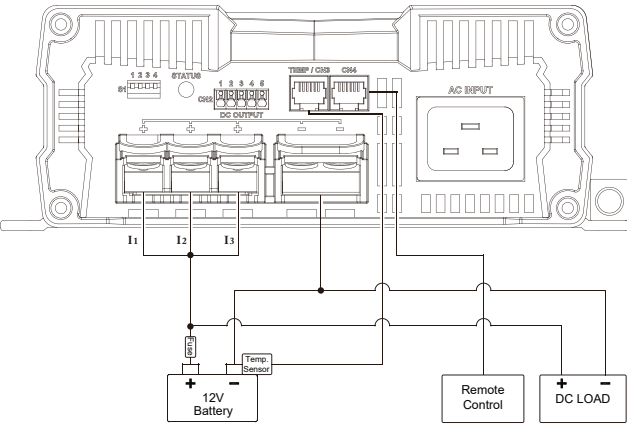
Modèle	Description	Schéma de câblage
<p>CX2415</p>	<p>I1 ou I2 12.5 A max</p>	 <p>Fusible : 32 V 23 A</p>
<p>CX1250 CX1280</p>	<p>I1I2I3 CX1250 : 50 A max CX1280 : 80 A max</p>	 <p>CX1250 - Fusible : 32 V 80 A CX1280 - Fusible : 32 V 125 A</p>

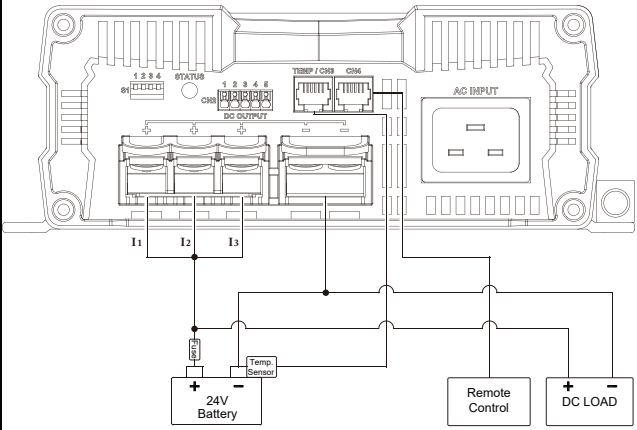
Modèle	Description	Schéma de câblage
CX2425 CX2440	I1+I2+I3 CX2425 : 25 A max CX2440 : 40 A max	 <p data-bbox="428 646 773 710"> CX2425 - Fusible : 32 V 40A CX2440 - Fusible : 32 V 80 A </p>

Légendes des schémas de câblage :

Battery : batterie

Remote Control : commande à distance

DC Load : consommateur CC

Extra Second Battery (ESB) : batterie supplémentaire

5. Recherche de pannes

LED	Cause	Remède
Rouge, flashes lents	Tension batterie basse ou surcharge	Vérifier l'état de la batterie. Éteindre puis redémarrer le chargeur.
	Batterie défectueuse	Remplacer la batterie.
Rouge, flashes rapides	Surchauffe	Améliorer la ventilation du chargeur ou de la batterie. S'assurer que les orifices de ventilation ne sont pas obstrués. Si possible, réduire la température ambiante.
Rouge, fixe	Court-circuit ou inversion de polarités	Refaire les branchements en respectant les polarités. Corriger le court-circuit. Vérifier l'état du fusible et le remplacer si nécessaire.
Rouge, flashes doubles	Défaut du ventilateur	Vérifier si le ventilateur est encrassé ou endommagé.
Rouge, flashes toutes les 2 secondes	Défaut de la batterie	Vérifier si la batterie est en court-circuit.

6. Garantie

6-1. Avertissement



Attention !

Ne pas ouvrir ni démonter le chargeur. Risques de chocs électriques voire d'incendie.

6-2. Garantie

Nous garantissons ce produit contre tout défaut de matériaux et de main-d'œuvre pour une durée de 24 mois. Pour toute demande de service après-vente, merci de contacter votre distributeur local.

Cette garantie sera considérée comme nulle si l'appareil n'a pas été utilisé de manière correcte, s'il a été modifié ou s'il a été endommagé accidentellement. COTEK ne saurait être tenu responsable d'aucun dommage résultant d'une faute de l'utilisateur.

COTEK

No.33, Sec. 2, Renhe Rd., Daxi Dist., Taoyuan City 33548, Taiwan

Phone : +886-3-3891999 FAX : +886-3-3802333

[http : // www.cotek.com.tw](http://www.cotek.com.tw)

2017.01._A0